

PROJECT NAME: _____ DATE: _____
 CATALOG#: _____ TYPE: _____

DĀLUME®

4" Continuum Linear Point Source - Surface Mount

Housing: Continuous, 6063-T5 extruded aluminum profile 4" wide endless number of trim modules. Standard plus custom lengths available. Systems more than 12' long, specify DMMS plus the # of feet. Joined with connecting brace for ease of installation to assure a uniform appearance. 65% recycled materials.

Integral Electronic Driver: 8W max per Trim Module. 120V ELV standard, 277V options available. EMI & RFI meets FCC part 15 (Class A) Auto Recovery. UL/CSA Listed.

Additional surge protection with this unit is recommended (supplied by others). Surge damage is not covered by warranty. Total wattage load is determined by the driver and number for modules used, please contact factory for details

Mounting/Power Source:

Universal mounting provided with cross bar and nipple for connection to J-Box. All power source components accessible from below. Optional Extended Adjustable Arm "-ADJ" for Signs, Walls & Ceilings. See Page 3 for details.

Optics/Media:

Q6 & Q8 2 lens/filter capacity, **Q7** 1 lens/filter capacity.

Finishes: Standard interior color white. (Smooth Gloss: Cardinal T007-WH121/RAL9003). Custom colors (**CC**) are available, please specify RAL# or Cardinal Paint# Custom Wood finish, Consult factory for details.

Optics: Premium binned LEDs provide exceptional reliability, performance and color consistency.

- High CRI of 80+ for accurate color presentation.
- Lumens Delivered : 4W (300Lm) or 8W (500 Lm) Module per foot
- Color Temperatures : (+/- 100K) 2,700K, 3,000, 4,000K, RGBW Color Changing
- L70 @ 80,000 hours with 25°C Ambient
- Beam Angle: Spot 15 Degree, Narrow Flood 25 Degree, Flood 38 Degree

Weight: 2.5lbs. per foot.

Warranty: Complete 5 year Warranty. (See catalog for details).

Listing: ETL listed to UL Standards for dry or damp locations. Fixture suitable for wet location under canopy/covered ceilings with "WL" option.

Made in USA.

LED Trim Module



Q6: 2" Square aperture with 0-20 degree internal positioning. Ideal for inconspicuous accent and down lighting.

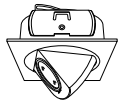

Q7: Fully adjustable pull-down head for maximum aiming of 0-85 degree.



Q8: 2" Round gimbal. 0-35 degree positioning.



Channel Profile

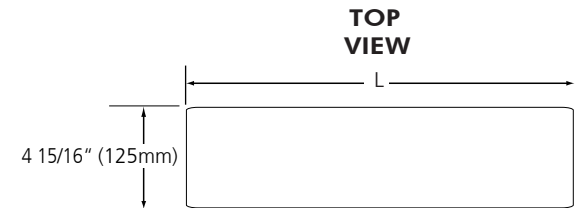
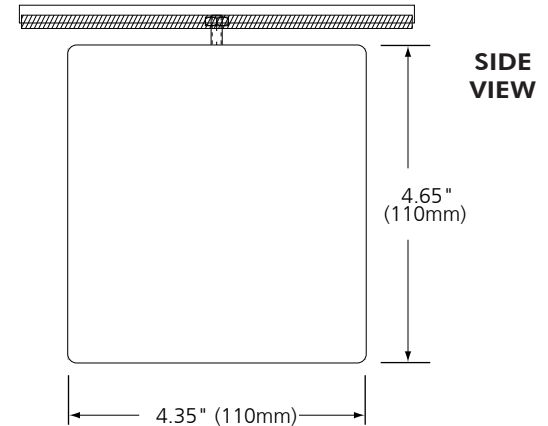

Length	L (In)	L (cm)	Length	L (In)	L (cm)
1 Lamp:	4.5"	11.43	5 Lamp:	22.5"	57.15
2 Lamp:	9"	22.86	6 Lamp:	27"	68.58
3 Lamp:	13.5"	34.29	7 Lamp:	31.5"	80.01
4 Lamp:	18"	45.72	Add'l Lamp:	add 4.5" or 11.43	

Ordering

Example DMM1Q8-4-SP-27K-SADJ

Ordering	# of LAMPINGS	SPOT TRIM	LED W/LAMP	BEAM SPREAD	COLOR TEMP	DRIVER	MOUNTING	FINISH
DMM	1: 1 LAMP 2: 2 LAMP 3: 3 LAMP 4: 4 LAMP 5: 5 LAMP 6: 6 LAMP X: X LAMP	-Q6 :Accent+ -Q7 :PullDown+ -Q8 :Gimbal+	04: 4W :(300Lm) 08: 8W :(500Lm)	-SP :Spot 15 deg. -NFL :Narrow Flood 25 deg. -FL :Flood 38 deg.	-27K :2700K -30K :3000K -40K :4000K -RGBW :RGBW	-Blank :120V ELV DIM -277 :277V	-S :Surface -SADJ :Surface Adjustable	-Blank : White -B : Black -CC : Custom

+ Add 4.5" to Channel per Trim

99063014

4" Continuum Linear Point Source - Surface Mount

Performance

OUTPUT PERFORMANCE

IES INDOOR REPORT Q7 & Q8 LED Module Only
 DMMI-8W-SP-30K.IES 3000K CCT / 87 CRI / 550 Lms

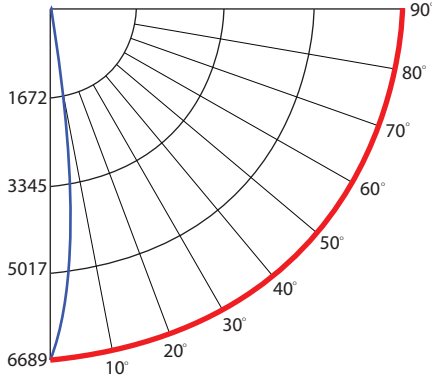

LUMINANCE DATE (cd/sq.m)

Angle In Degrees	Average 0-Deg	Average 45-Deg	Average 90-Deg
45	5950	5950	6320
55	6287	6287	6264
65	8533	8533	6221
75	20319	20319	20319
85	49996	49996	49996

OUTPUT PERFORMANCE

IES INDOOR REPORT Q7 & Q8 LED Module Only
 DMMI-8W-NFL-30K.IES 3000K CCT / 87 CRI / 500 Lms

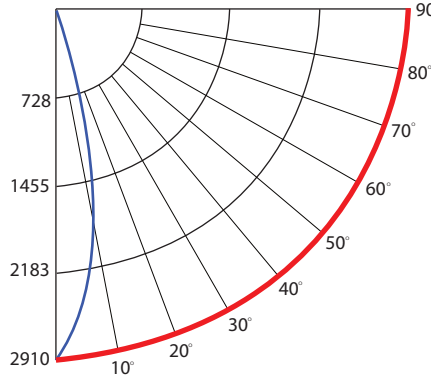

LUMINANCE DATE (cd/sq.m)

Angle In Degrees	Average 0-Deg	Average 45-Deg	Average 90-Deg
45	6320	6320	6320
55	6264	6264	6264
65	6221	6221	6221
75	19637	19637	19637
85	50272	50272	50272

OUTPUT PERFORMANCE

IES INDOOR REPORT Q7 & Q8 LED Module Only
 DMMI-8W-FL-30K.IES 3000K CCT / 87 CRI / 500 Lms

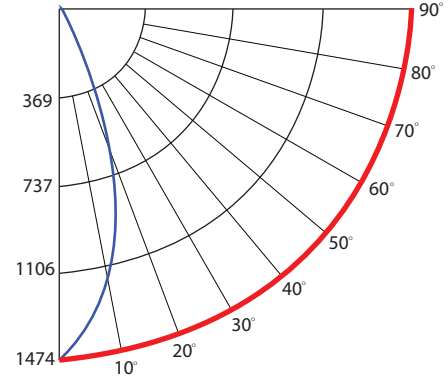

LUMINANCE DATE (cd/sq.m)

Angle In Degrees	Average 0-Deg	Average 45-Deg	Average 90-Deg
45	11401	11401	11401
55	9167	9167	9167
65	12026	12026	12026
75	10834	10834	10834
85	10054	10054	10054

ZONAL LUMEN SUMMARY

Zone	Lumens
0 - 10	355.03
10 - 20	128.56
20 - 30	31.63
30 - 40	10.33
40 - 50	4.54
50 - 60	4.36
60 - 70	5.12
70 - 80	7.17
80 - 90	6.57
90 - 100	.15
100 - 110	.0

ZONAL LUMEN SUMMARY

Zone	Lumens
0 - 10	223.79
10 - 20	225.33
20 - 30	22.58
30 - 40	6.53
40 - 50	3.9
50 - 60	3.48
60 - 70	3.47
70 - 80	6.07
80 - 90	5.34
90 - 100	2.22
100 - 110	.02

ZONAL LUMEN SUMMARY

Zone	Lumens
0 - 10	128.16
10 - 20	248.02
20 - 30	86.25
30 - 40	10.37
40 - 50	6.91
50 - 60	5.56
60 - 70	5.61
70 - 80	3.44
80 - 90	1.23
90 - 100	1.91
100 - 110	2.72
110 - 120	.17

99051914

4" Continuum Linear Point Source - Surface Mount

Example Configuration Layout

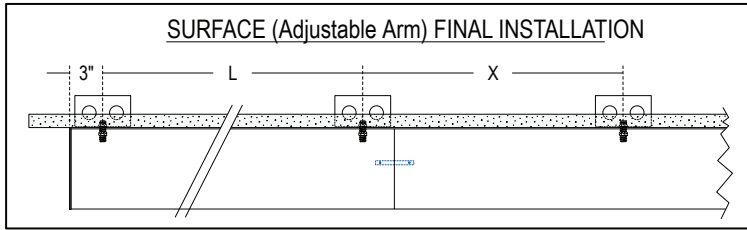

Luminaire Length	# of Supports Equally Spaced	Center to Center Length (L)	Center to Center Length (X)	Mounting Application
1 ft	1	6"	12"	
2 ft	2	18"	24"	
3 ft		30"	36"	
4 ft		42"	48"	
5 ft	3	54"	60"	
6 ft		33"	36"	
7 ft		39"	42"	
8 ft		45"	48"	
9 ft		51"	54"	
10 ft		57"	61"	
11 ft	63"	66"		
12 ft	69"	72"		

4" Continuum Linear LED - Surface Mount

Custom Finishes (Wood Grain & Solid)

Dalume's Continuum Linear System is engineered with a heavy gauge 6063-T5 extruded aluminum and is offered in standard White powder coat finish. Custom wood pattern finishes may be applied in addition to solid color tones.



LIGHT MAPLE:
 Modern & clean wood grain finish fuses well light colored room themes.
 <
 Specify: CC-LM



MEDITERRANEAN:
 Warm wood grain finish fuses well earth tone room themes.
 <
 Specify: CC-Med



REDWOOD:
 Deep Redwood grain finish fuses well with dark colored room themes.
 <
 Specify: CC-RW



DARK WHEAT:
 Bold and bright grain finish is versatile with light & dark colored room themes.
 <
 Specify: CC-DW



NAT'L WALNUT:
 Brown grain finish fuses well with mid-tone colored room themes.
 <
 Specify: CC-NW



CUSTOM COLOR:
 A solid paint palette to match any creative room.
 <
 Specify: CC-

 Raaal or Pantone color code

2015.23.03