

PROJECT NAME: _____ DATE: _____
 CATALOG#: _____ TYPE: _____

4" Continuum Linear Point Source - Pendant Mount (D)

Housing: Continuous, 6063-T5 extruded aluminum profile 4" wide endless number of trim modules. Standard plus custom lengths available. Systems more than 12' long, specify DMMS plus the # of feet. Joined with connecting brace for ease of installation to assure a uniform appearance. 65% recycled materials.

Integral Electronic Driver: 8W max per Trim Module. 120V ELV standard, 277V options available. EMI & RFI meets FCC part 15 (Class A) Auto Recovery. UL/CSA Listed.

Additional surge protection with this unit is recommended (supplied by others). Surge damage is not covered by warranty. Total wattage load is determined by the driver and number for modules used, please contact factory for details.

Mounting/Power Source:

Universal mounting to any structural ceiling via Jbox. (1) 50" Power feed canopy kit per circuit and support kits provided. See page 3 for support spacing. All power source components accessible from below except to JBox.

Optics/Media:

Q6 & Q8 2 lens/filter capacity, **Q7** 1 lens/filter capacity.

Finishes: Standard interior color white. (Smooth Gloss: Cardinal T007-WH121/RAL9003). Custom colors (**CC**) are available, please specify RAL# or Cardinal Paint# Custom Wood finish, Consult factory for details.

Optics: Premium binned LEDs provide exceptional reliability, performance and color consistency.

- High CRI of 80+ for accurate color presentation.
- Lumens Delivered : 4W (300Lm) or 8W (500 Lm) Module per foot
- Color Temperatures : (+/- 100K) 2,700K, 3,000, 4,000K, RGBW Color Changing
- L70 @ 80,000 hours with 25°C Ambient
- Beam Angle: Spot 15 Degree, Narrow Flood 25 Degree, Flood 38 Degree

Weight: 2.5lbs. per foot.

Warranty: Complete 5 year Warranty. (See catalog for details).

Listing: ETL listed to UL Standards for dry or damp locations. Fixture suitable for wet location under canopy/covered ceilings with "WL" option

Made in USA.

LED Trim Module



Q6: 2" Square aperture with 0-20 degree internal positioning. Ideal for inconspicuous accent and down lighting.

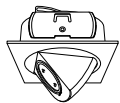

Q7: Fully adjustable pull-down head for maximum aiming of 0-85 degree.

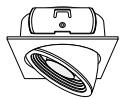

Q8: 2" Round gimbal. 0-35 degree positioning.



Channel Profile

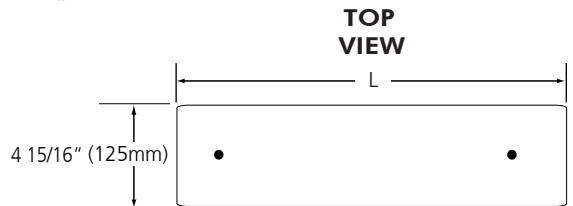
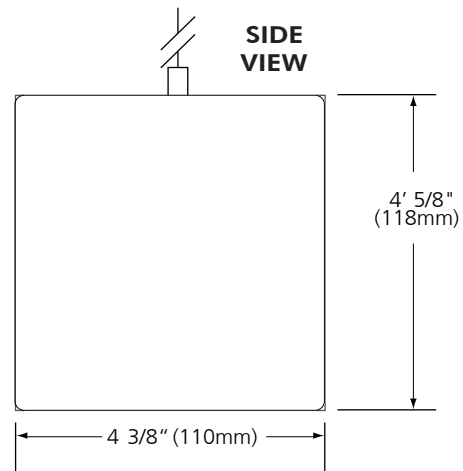

| Length | L (In) | L (cm) | Length | L (In) | L (cm) |
|----------------|--------|--------|--------------------|-------------------|--------|
| 1 Lamp: | 4.5" | 11.43 | 5 Lamp: | 22.5" | 57.15 |
| 2 Lamp: | 9" | 22.86 | 6 Lamp: | 27" | 68.58 |
| 3 Lamp: | 13.5" | 34.29 | 7 Lamp: | 31.5" | 80.01 |
| 4 Lamp: | 18" | 45.72 | Add'l Lamp: | add 4.5" or 11.43 | |

Ordering

Example: DMM1Q64W-SP-27K-D

| Ordering | # of LAMPINGS | SPOT TRIM | LED W/LAMP | BEAM SPREAD | COLOR TEMP | DRIVER | MOUNTING | FINISH |
|------------|--|---|--|--|--|--|--------------------------------------|---|
| DMM | 1: 1 LAMP 2: 2 LAMP 3: 3 LAMP 4: 4 LAMP 5: 5 LAMP 6: 6 LAMP X: X LAMP | -Q6 :Accent+ -Q7 :PullDown+ -Q8 :Gimbal+ | 04: 4W : (300Lm) 08: 8W : (500Lm) | -SP :Spot 15 deg. -NFL :Narrow Flood 25 deg. -FL :Flood 38 deg. | -27K :2700K -30K :3000K -40K :4000K -RGBW :RGBW | -Blank :120V ELV DIM -277 :277V | PENDANT -D :Pendant | -Blank : White -B : Black -CC : Custom |

+ Add 4.5" to Channel per Trim

2017.24.01

4" Continuum Linear Point Source - Pendant Mount (D) Performance

OUTPUT PERFORMANCE

IES INDOOR REPORT Q7 & Q8 LED Module Only
 DMMI-0W-SP-30K.IES 3000K CCT / 87 CRI / 550 Lms

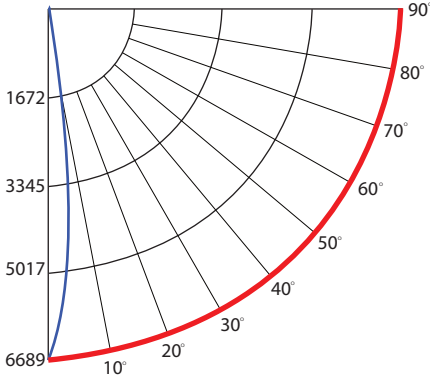

LUMINANCE DATE (cd/sq.m)

| Angle In Degrees | Average 0-Deg | Average 45-Deg | Average 90-Deg |
|------------------|---------------|----------------|----------------|
| 45 | 5950 | 5950 | 6320 |
| 55 | 6287 | 6287 | 6264 |
| 65 | 8533 | 8533 | 6221 |
| 75 | 20319 | 20319 | 20319 |
| 85 | 49996 | 49996 | 49996 |

OUTPUT PERFORMANCE

IES INDOOR REPORT Q7 & Q8 LED Module Only
 DMMI-0W-NFL-30K.IES 3000K CCT / 87 CRI / 500 Lms

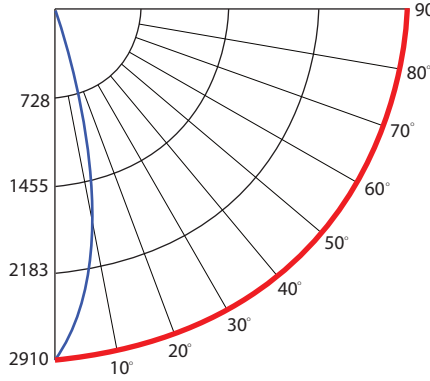

LUMINANCE DATE (cd/sq.m)

| Angle In Degrees | Average 0-Deg | Average 45-Deg | Average 90-Deg |
|------------------|---------------|----------------|----------------|
| 45 | 6320 | 6320 | 6320 |
| 55 | 6264 | 6264 | 6264 |
| 65 | 6221 | 6221 | 6221 |
| 75 | 19637 | 19637 | 19637 |
| 85 | 50272 | 50272 | 50272 |

OUTPUT PERFORMANCE

IES INDOOR REPORT Q7 & Q8 LED Module Only
 DMMI-0W-FL-30K.IES 3000K CCT / 87 CRI / 500 Lms

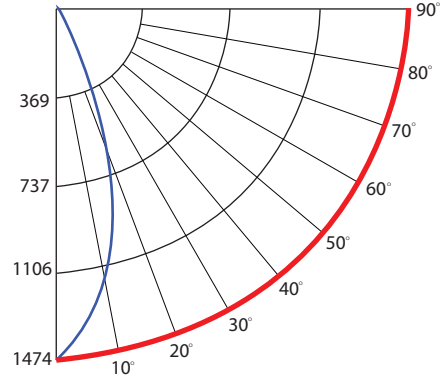

LUMINANCE DATE (cd/sq.m)

| Angle In Degrees | Average 0-Deg | Average 45-Deg | Average 90-Deg |
|------------------|---------------|----------------|----------------|
| 45 | 11401 | 11401 | 11401 |
| 55 | 9167 | 9167 | 9167 |
| 65 | 12026 | 12026 | 12026 |
| 75 | 10834 | 10834 | 10834 |
| 85 | 10054 | 10054 | 10054 |

ZONAL LUMEN SUMMARY

| Zone | Lumens |
|-----------|--------|
| 0 - 10 | 355.03 |
| 10 - 20 | 128.56 |
| 20 - 30 | 31.63 |
| 30 - 40 | 10.33 |
| 40 - 50 | 4.54 |
| 50 - 60 | 4.36 |
| 60 - 70 | 5.12 |
| 70 - 80 | 7.17 |
| 80 - 90 | 6.57 |
| 90 - 100 | .15 |
| 100 - 110 | .0 |

ZONAL LUMEN SUMMARY

| Zone | Lumens |
|-----------|--------|
| 0 - 10 | 223.79 |
| 10 - 20 | 225.33 |
| 20 - 30 | 22.58 |
| 30 - 40 | 6.53 |
| 40 - 50 | 3.9 |
| 50 - 60 | 3.48 |
| 60 - 70 | 3.47 |
| 70 - 80 | 6.07 |
| 80 - 90 | 5.34 |
| 90 - 100 | 2.22 |
| 100 - 110 | .02 |

ZONAL LUMEN SUMMARY

| Zone | Lumens |
|-----------|--------|
| 0 - 10 | 128.16 |
| 10 - 20 | 248.02 |
| 20 - 30 | 86.25 |
| 30 - 40 | 10.37 |
| 40 - 50 | 6.91 |
| 50 - 60 | 5.56 |
| 60 - 70 | 5.61 |
| 70 - 80 | 3.44 |
| 80 - 90 | 1.23 |
| 90 - 100 | 1.91 |
| 100 - 110 | 2.72 |
| 110 - 120 | .17 |

99051914

4" Continuum Linear Point Source - Pendant Mount (D)

Example Configuration Layout

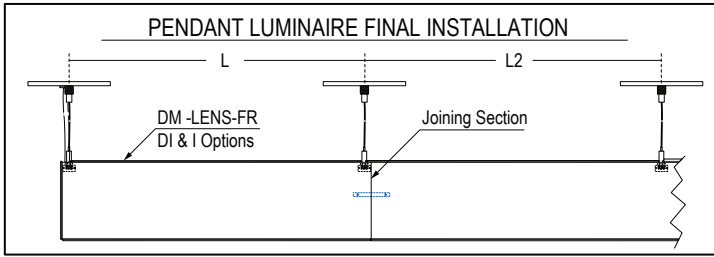

| Luminaire Length | # of Supports Equally Spaced | Center to Center Length (L) | Center to Center Length (L2) | Mounting Application |
|------------------|------------------------------|-----------------------------|------------------------------|----------------------|
| 2 ft | 2 | 23.0" | 24.0" | |
| 3 ft | | 36.0" | 36.0" | |
| 4 ft | | 47.0" | 48.0" | |
| 5 ft | | 69.0" | 60.0" | |
| 6 ft | | 71.0" | 72.0" | |
| 7 ft | | 83.0" | 84.0" | |
| 8 ft | | 95.0" | 96.0" | |
| 9 ft | 3 | 53.5" | 54.0" | |
| 10 ft | | 59.5" | 60.0" | |
| 11 ft | | 65.5" | 66.0" | |
| 12 ft | | 71.5" | 72" | |

4" Continuum Linear LED - Pendant Mount (D)

Custom Finishes (Wood Grain & Solid)

Dalume's Continuum Linear System is engineered with a heavy gauge 6063-T5 extruded aluminum and is offered in standard White powder coat finish. Custom wood pattern finishes may be applied in addition to solid color tones.



LIGHT MAPLE:
 Modern & clean wood grain finish fuses well light colored room themes.
 <
 Specify: CC-LM



MEDITERRANEAN:
 Warm wood grain finish fuses well earth tone room themes.
 <
 Specify: CC-Med



REDWOOD:
 Deep Redwood grain finish fuses well with dark colored room themes.
 <
 Specify: CC-RW



DARK WHEAT:
 Bold and bright grain finish is versatile with light & dark colored room themes.
 <
 Specify: CC-DW



NAT'L WALNUT:
 Brown grain finish fuses well with mid-tone colored room themes.
 <
 Specify: CC-NW

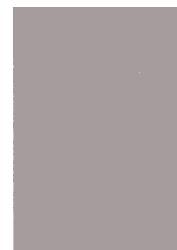

CUSTOM COLOR:
 A solid paint palette to match any creative room.
 <
 Specify: CC-

 Raal or Pantone color code

2015.23.03