

DCG 3/4/5

Remarkable Installation Savings

Up 60% faster installation
Over 40% material cost saving

Wire Diagram:



GridLyte is compatible with 1/2" to 1" T-Bar Profiles

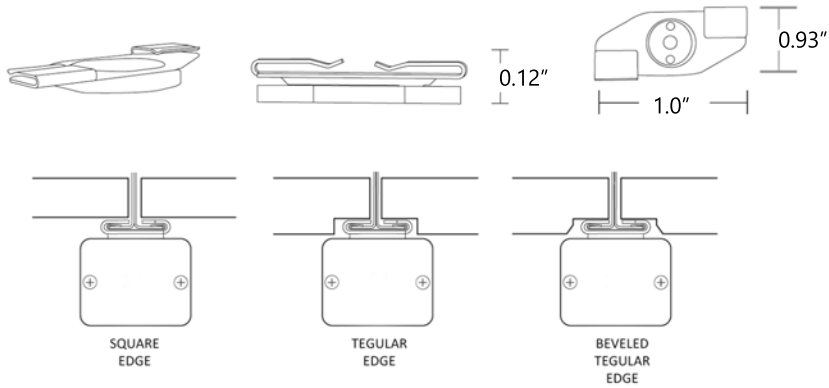

An innovative lighting product solution for T-Grid suspension ceilings

Product Line Drawing :

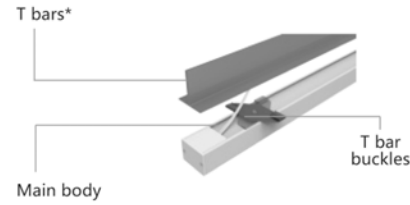

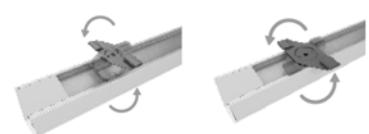

* T bar is not included in the product packaging. The T bar is apart of the ceiling. It is not neccessary to modify the T bar to insatall T Grid Lighting System.

Installation steps:

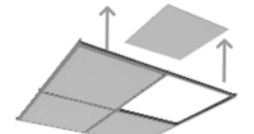
- 

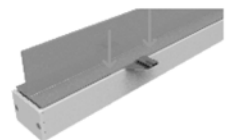
1. Move the hanger toward to the end cap as much as possible and turn the hanger vertically to the light fitting.
- 

2. Remove the tiles from the T grid for easy installation.
- 

3. Place Fixture under the T bar closely.
- 

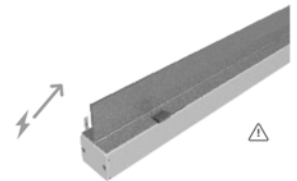
4. Turn the hanger clockwise and lock the hanger to the T bars.
- 

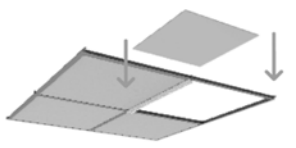
5. Place the Low Voltage cable alongside the T bar and connect to power Supply.
- 

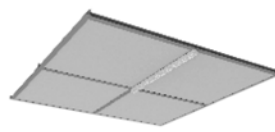
6. Place the tiles back to the ceiling.
- 

7. Now the installation is completed.